

MADE IN ITALY. MADE TO EXCEL.

BOOST ICOR

Interactive version



 atlas concorde

September 2024

STONE LOOK

WALL TILES

Rivestimenti
Revêtements
Wandfliesen
Revestimientos
Настенная плитка

PORCELAIN TILES

Gres Porcellanato
Grès cérame
Feinsteinzeug
Gres porcelánico
Керамический гранит



Atlas Concorde is one of the leading global brands in the production of ceramic tiles and large slabs for design and architecture. With over 50 years of history, two production plants, and numerous showroom in the capitals of international design, Atlas Concorde offers integrated and sustainable ceramic systems for floors, walls, outdoor spaces, worktops, bathroom furnishings, facades and special projects. Design your world with Atlas Concorde.

Atlas Concorde è uno dei principali brand mondiali nella produzione di superfici e grandi lastre ceramiche per il design e l'architettura. Con oltre cinquant'anni di storia, due stabilimenti produttivi, numerose showroom nelle capitali della progettazione internazionale, offriamo sistemi ceramici integrati e sostenibili per pavimenti, rivestimenti, outdoor, piani di lavoro, arredo bagno, facciate e progetti speciali. Design your world with Atlas Concorde.

atlasconcorde.com

INDEX

- ↳ INSPIRATION
- ↳ ARCHEA X ATLAS CONCORDE
- ↳ IMAGE GALLERY
- ↳ SURFACE RANGE & TECHNICAL SPECIFICATION

INDEX



INSPIRATION >

ARCHEA X
ATLAS CONCORDE >

IMAGE
GALLERY >

SURFACE
RANGE &
TECHNICAL
SPECS >

ENJOY
THE VIDEO

INDEX



INSPIRATION



ARCHEA X
ATLAS CONCORDE



IMAGE
GALLERY



SURFACE
RANGE &
TECHNICAL
SPECS



ENJOY
THE VIDEO



ELEGANCE

TO LAST

INDEX



INSPIRATION



ARCHEA X
ATLAS CONCORDE



IMAGE
GALLERY



SURFACE
RANGE &
TECHNICAL
SPECS



ENJOY
THE VIDEO



INSPIRED BY

LIMESTONE

INDEX



INSPIRATION



ARCHEA X
ATLAS CONCORDE



IMAGE
GALLERY



SURFACE
RANGE &
TECHNICAL
SPECS



ENJOY
THE VIDEO



DUST

BONE

OYSTER

CRETE

SIDERAL

DUNE

SIX BRIGHT

SHADES

INDEX



INSPIRATION



ARCHEA X
ATLAS CONCORDE



IMAGE
GALLERY



SURFACE
RANGE &
TECHNICAL
SPECS



ENJOY
THE VIDEO



PLEASANT

INDOOR

INDEX



INSPIRATION



ARCHEA X
ATLAS CONCORDE



IMAGE
GALLERY



SURFACE
RANGE &
TECHNICAL
SPECS



ENJOY
THE VIDEO



VIBRANT

OUTDOOR



NATURAL

INDEX



INSPIRATION



ARCHEA X
ATLAS CONCORDE



IMAGE
GALLERY



SURFACE
RANGE &
TECHNICAL
SPECS



ENJOY
THE VIDEO

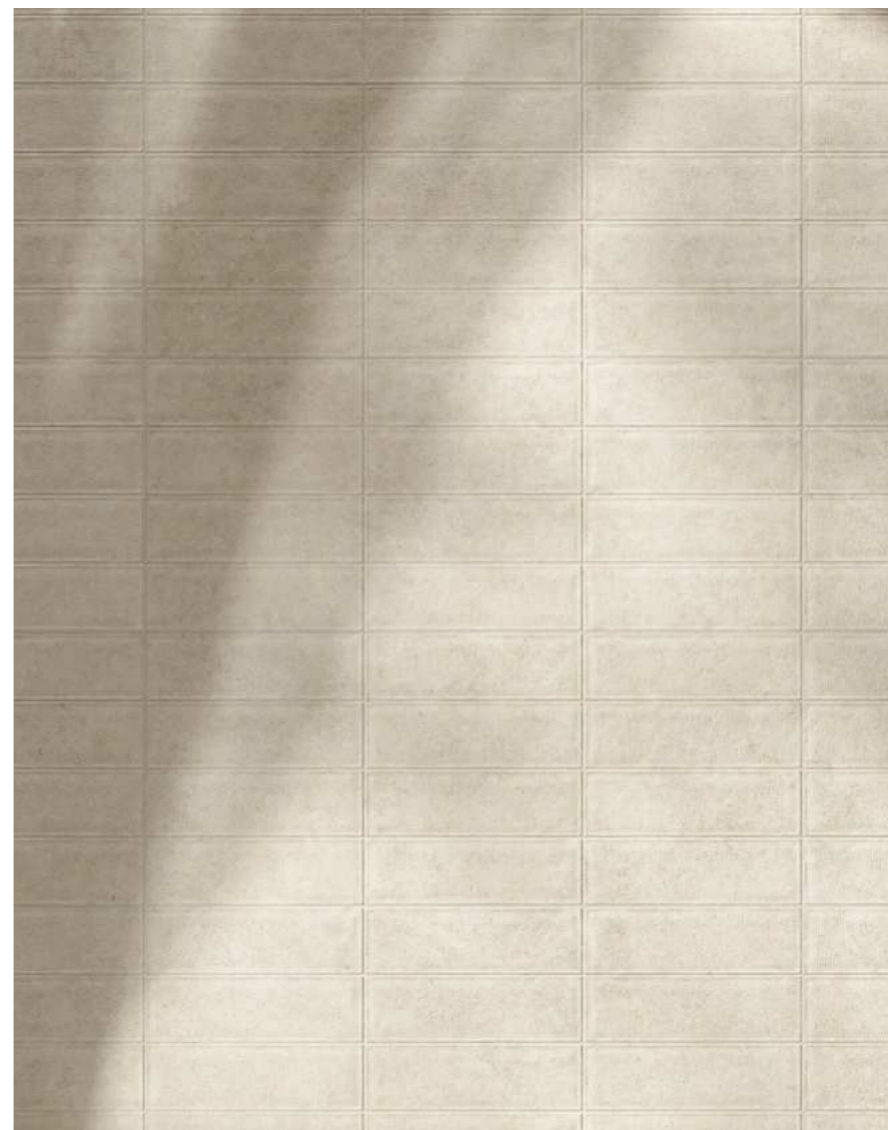

RELIEF

INSPIRED DESIGN

MARCO CASAMONTI / ARCHEA ASSOCIATI

Laura Andreini, Marco Casamonti, and Giovanni Polazzi, who graduated in Architecture from the University of Florence, founded Studio Archea in 1988. In 2001, Silvia Fabi joined the team, leading to the creation of Archea Associati. The firm has carried out projects worldwide and today has offices in Europe, China, the UAE, Brazil, and Albania. They have taken part in international competitions, earning several prestigious awards, and completing major projects such as the Antinori Winery and the Air Albania Stadium. In addition to design, they are actively involved in research and teaching, regularly publishing essays and magazines, and organizing exhibitions, events, and workshops in prestigious settings such as the Venice Biennale.

Laura Andreini, Marco Casamonti e Giovanni Polazzi, laureati in Architettura presso l'Università di Firenze, hanno fondato Studio Archea nel 1988. Nel 2001 si è unita a loro Silvia Fabi, dando vita ad Archea Associati. Lo studio ha realizzato progetti in tutto il mondo e oggi ha sedi in Europa, Cina, Emirati Arabi, Brasile e Albania. Hanno partecipato a concorsi internazionali e vinto diversi premi importanti, realizzando grandi progetti come le Cantine Antinori e l'Air Albania Stadium. Oltre alla progettazione, si dedicano attivamente alla ricerca e all'insegnamento, pubblicano saggi e riviste, e organizzano mostre, eventi e workshop in contesti prestigiosi, come la Biennale di Venezia.

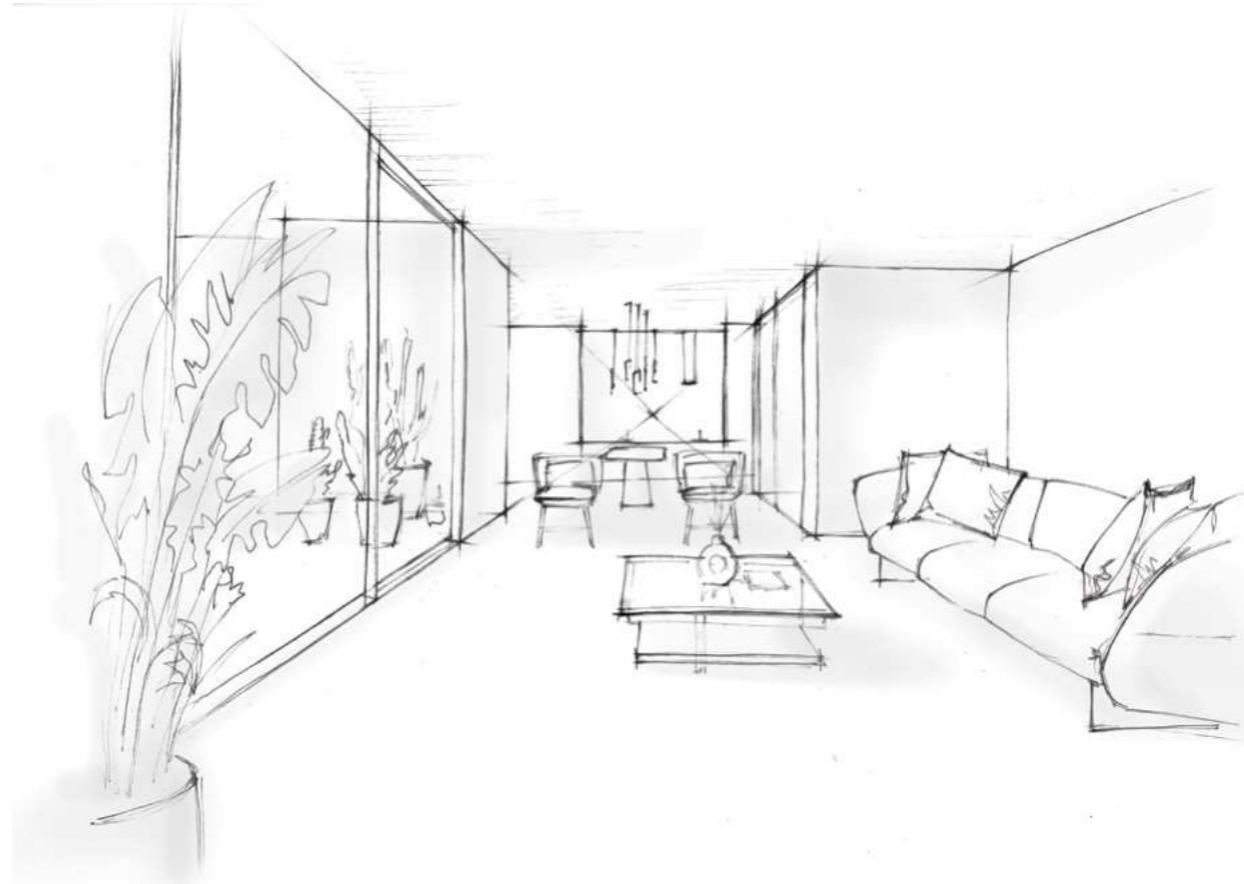

Antinori in the Chianti Classico Italy >

ARCHEA ASSOCIATI X atlas concorde

Archea Associati has crafted six indoor-outdoor spaces, placing the diverse applications and compositional possibilities of Boost Icor at the heart of their creative process. Each detail is meticulously designed to highlight the material qualities of floors and coverings, seamlessly integrating them into modern architectural settings, and complemented by an extensive range of decorative elements. The design harmoniously blends functionality with aesthetics, allowing the ceramic products to stand out and impart a timeless sense of naturalness and elegance to the spaces.

Archea Associati ha concepito sei ambienti interni-esterni, mettendo al centro del processo creativo le molteplici possibilità di utilizzo e compositive offerte da Boost Icor. Ogni dettaglio è stato pensato per esaltare la matericità di pavimenti e rivestimenti in contesti architettonici dalla bellezza contemporanea, anche attraverso l'ampio apparato decorativo. Grazie ad una progettazione che fonde funzionalità ed estetica, il prodotto ceramico si rende protagonista, conferendo agli spazi una naturalità ed eleganza senza tempo.

INDEX



INSPIRATION >

ARCHEA X ATLAS CONCORDE >

IMAGE GALLERY >

SURFACE RANGE & TECHNICAL SPECS >

ENJOY THE VIDEO 

IMAGE

INDEX



INSPIRATION



ARCHEA X
ATLAS CONCORDE



IMAGE
GALLERY



LIVING VILLA WITH EXT.
LIVING KITCHEN
BATHROOM
VILLA WITH POOL
SPA
LOBBY RESORT
COMMERCIAL

SURFACE
RANGE &
TECHNICAL
SPECS



ENJOY
THE VIDEO



↔ LIVING VILLA WITH EXTERIOR - BREATHING SPACES



↔ LIVING KITCHEN - NATURAL CONVIVIALITY



↔ BATHROOM - PERSONAL SPACE



↔ VILLA WITH POOL - GENTLE DELIGHT



↔ SPA - MOMENT IN TIME



↔ LOBBY RESORT - QUIET HOSPITALITY



↔ COMMERCIAL - BRAND ELEVATION



GALLERY



Space designed by
MARCO CASAMONTI / ARCHEA ASSOCIATI

OUTDOOR FLOOR
Boost Icor
Dune

BREATHING

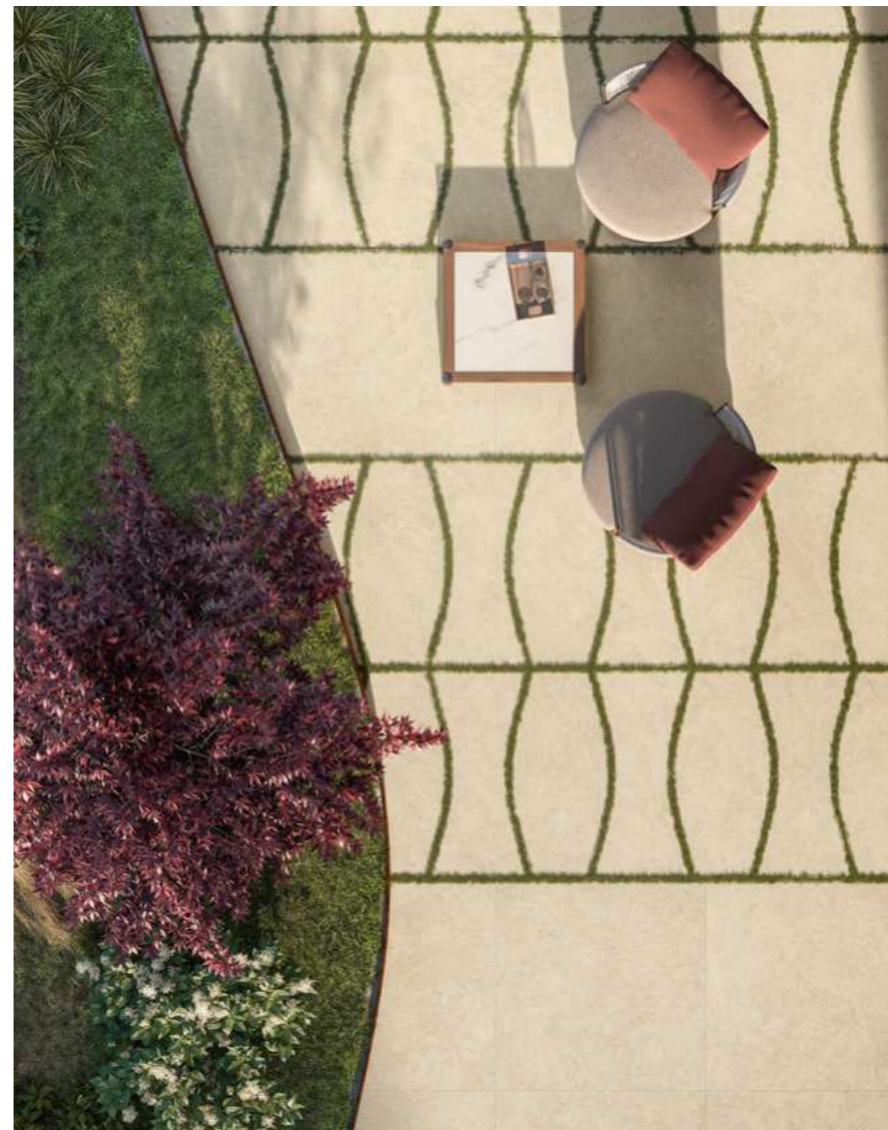

INDEX



INSPIRATION



ARCHEA X
ATLAS CONCORDE



IMAGE
GALLERY



LIVING VILLA WITH EXT.
LIVING KITCHEN
BATHROOM
VILLA WITH POOL
SPA
LOBBY RESORT
COMMERCIAL

SURFACE
RANGE &
TECHNICAL
SPECS



ENJOY
THE VIDEO



SPACES

INDEX



INSPIRATION



ARCHEA X
ATLAS CONCORDE



IMAGE
GALLERY



LIVING VILLA WITH EXT.
LIVING KITCHEN
BATHROOM
VILLA WITH POOL
SPA
LOBBY RESORT
COMMERCIAL

SURFACE
RANGE &
TECHNICAL
SPECS



ENJOY
THE VIDEO



INDOOR FLOOR
Boost Icor
Dune
Matte Sensitech
120x120 (47 1/4" x 47 1/4")

OUTDOOR FLOOR
Boost Icor
Dune
Outdoor Sensitech * 20 mm
120x120 (47 1/4" x 47 1/4")

OUTDOOR FLOOR
Boost Icor
Dune Combo A
Outdoor Sensitech - 20mm
48.4x119 (19 1/8" x 46 7/8")

Boost Icor
Dune Combo B
Outdoor Sensitech - 20mm
42.5x119 (16 3/4" x 46 7/8")

INDEX



INSPIRATION



ARCHEA X
ATLAS CONCORDE



IMAGE
GALLERY



LIVING VILLA WITH EXT.
LIVING KITCHEN
BATHROOM
VILLA WITH POOL
SPA
LOBBY RESORT
COMMERCIAL

SURFACE
RANGE &
TECHNICAL
SPECS



ENJOY
THE VIDEO



^
INDOOR FLOOR
Boost Icor
Dune
Matte Sensitech
120x120 (47¹/₄"x94¹/₂")

WALL
Boost Icor
Dune Furnace
Mosaico Matte
30x19,5 (11³/₄"x7⁵/₈") >

INDOOR FLOOR
Boost Icor
Dune
Matte Sensitech
120x240 (47¹/₄"x94¹/₂") >





<
 WALL
Boost Icor
Dune Furnace
 Mosaico Matte
 30x19,5 (11³/₄"x7⁵/₈"



^
 INDOOR FLOOR
Boost Icor
Dune
 Matte Sensitech
 120x240 (47¹/₄"x47¹/₄"

- INDEX ≡

- INSPIRATION >

- ARCHEA X ATLAS CONCORDE >

- IMAGE GALLERY >

- LIVING VILLA WITH EXT.
 LIVING KITCHEN
 BATHROOM
 VILLA WITH POOL
 SPA
 LOBBY RESORT
 COMMERCIAL

- SURFACE RANGE & TECHNICAL SPECS >

- ENJOY THE VIDEO ▶

NATURAL



FLOOR
Boost Icor
Sideral

Space designed by
MARCO CASAMONTI / ARCHEA ASSOCIATI



CONVIVIALITY

INDEX



INSPIRATION



ARCHEA X
ATLAS CONCORDE



IMAGE
GALLERY



LIVING VILLA WITH EXT.
LIVING KITCHEN
BATHROOM
VILLA WITH POOL
SPA
LOBBY RESORT
COMMERCIAL

SURFACE
RANGE &
TECHNICAL
SPECS



ENJOY
THE VIDEO



INDEX



INSPIRATION



ARCHEA X
ATLAS CONCORDE



IMAGE
GALLERY



LIVING VILLA WITH EXT.
LIVING KITCHEN
BATHROOM
VILLA WITH POOL
SPA
LOBBY RESORT
COMMERCIAL

SURFACE
RANGE &
TECHNICAL
SPECS



ENJOY
THE VIDEO



INDOOR FLOOR
Boost Icor
Sideral
Matte Sensitech
120x120 (47¹/₄"x47¹/₄")

WALL
Boost Icor
Dust
Matte
120x278 (47¹/₄"x109¹/₂")

Boost Icor
Dust Furnace
Mosaico Matte
30x19,5 (11¹³/₁₆"x7¹¹/₁₆")

COUNTERTOP
Atlas Plan
Boost Icor Bone
Hammered ± 12 mm
162x324 (63³/₄"x127¹/₂")



<
OUTDOOR FLOOR
Boost Icor
Sideral
Outdoor Sensitech ✱ 20 mm
120x120 (47¹/₄"x47¹/₄"

WALL
Boost Icor
Dust Furnace
Mosaico Matte
30x19,5 (11¹³/₁₆"x7¹¹/₁₆"
v

INDEX 

INSPIRATION 



ARCHEA X
ATLAS CONCORDE 

IMAGE
GALLERY 

LIVING VILLA WITH EXT.
LIVING KITCHEN
BATHROOM
VILLA WITH POOL
SPA
LOBBY RESORT
COMMERCIAL

SURFACE
RANGE &
TECHNICAL
SPECS 

ENJOY
THE VIDEO 





Space designed by
MARCO CASAMONTI / ARCHEA ASSOCIATI

FLOOR
Boost Icor
Dust

PERSONAL



INDEX



INSPIRATION



ARCHEA X
ATLAS CONCORDE



IMAGE
GALLERY



LIVING VILLA WITH EXT.
LIVING KITCHEN
BATHROOM

VILLA WITH POOL
SPA
LOBBY RESORT
COMMERCIAL

SURFACE
RANGE &
TECHNICAL
SPECS



ENJOY
THE VIDEO



SPACE

INDEX



INSPIRATION



ARCHEA X
ATLAS CONCORDE



IMAGE
GALLERY



LIVING VILLA WITH EXT.
LIVING KITCHEN
BATHROOM

VILLA WITH POOL
SPA
LOBBY RESORT
COMMERCIAL

SURFACE
RANGE &
TECHNICAL
SPECS



ENJOY
THE VIDEO



FLOOR
Boost Icor
Dust
Matte Sensitech
60x120 (23⁵/₈"x47¹/₄"

WALL
Boost Icor
Dust
Matte
50x120 (19⁵/₈"x47¹/₄"

Boost Icor
3D Wheat Dust
Matte
50x120 (19⁵/₈"x47¹/₄"

VANITY UNIT | ARMONIA
Atlas Concorde Habitat
Boost Icor Dust
Matte
Rectangular Basin White Matte
120x45x53 (47¹/₄"x17³/₄" x20⁷/₈"

INDEX



INSPIRATION



ARCHEA X
ATLAS CONCORDE



IMAGE
GALLERY



LIVING VILLA WITH EXT.
LIVING KITCHEN
BATHROOM

VILLA WITH POOL
SPA
LOBBY RESORT
COMMERCIAL

SURFACE
RANGE &
TECHNICAL
SPECS



ENJOY
THE VIDEO



^
FLOOR
Boost Icor
Dust
Matte Sensitech
60x120 (23⁵/₈"x47¹/₄")

WALL
Boost Icor
3D Wheat Dust
Matte
50x120 (19⁵/₈"x47¹/₄") >





FLOOR
Boost Icor
Oyster

GENTLE



DELIGHT

INDEX



INSPIRATION



ARCHEA X
ATLAS CONCORDE



IMAGE
GALLERY



LIVING VILLA WITH EXT.
LIVING KITCHEN
BATHROOM
VILLA WITH POOL
SPA
LOBBY RESORT
COMMERCIAL

SURFACE
RANGE &
TECHNICAL
SPECS



ENJOY
THE VIDEO



INDEX



INSPIRATION



ARCHEA X
ATLAS CONCORDE



IMAGE
GALLERY



LIVING VILLA WITH EXT.
LIVING KITCHEN
BATHROOM
VILLA WITH POOL
SPA
LOBBY RESORT
COMMERCIAL

SURFACE
RANGE &
TECHNICAL
SPECS



ENJOY
THE VIDEO



OUTDOOR FLOOR
Boost Icor
Oyster Pebble A+B
Outdoor Sensitech \pm 20 mm
59,5x59,5 (23³/₈"x23³/₈")

Boost Icor
Oyster
Outdoor Sensitech \pm 20 mm
120x120 (47¹/₄"x47¹/₄")

Boost Icor
Oyster Elemento L
Outdoor Sensitech \pm 20 mm
33x120 (13"x47¹/₄")

Boost Icor
Oyster Alzata 20x120 SP
Outdoor Sensitech \pm 20 mm
20x120 (7⁷/₈"x47¹/₄")



INDEX



INSPIRATION



ARCHEA X
ATLAS CONCORDE



IMAGE
GALLERY



LIVING VILLA WITH EXT.
LIVING KITCHEN
BATHROOM
VILLA WITH POOL
SPA
LOBBY RESORT
COMMERCIAL

SURFACE
RANGE &
TECHNICAL
SPECS



ENJOY
THE VIDEO



OUTDOOR FLOOR
Boost Icor
Oyster
Outdoor Sensitech ✕ 20 mm
120x120 (47¹/₄"x47¹/₄"





^
 OUTDOOR FLOOR
Boost Icor
Oyster
 Outdoor Sensitech ± 20 mm
 120x120 (47 1/4" x 47 1/4")

>
 WALL
Boost Icor
Dust
 Matte
 120x278 (47 1/4" x 109 1/2")

>
 FLOOR
Boost Icor
Oyster
 Matte Sensitech
 120x120 (47 1/4" x 47 1/4")



INDEX



INSPIRATION



ARCHEA X
ATLAS CONCORDE



IMAGE
GALLERY



LIVING VILLA WITH EXT.
LIVING KITCHEN
BATHROOM
VILLA WITH POOL
SPA
LOBBY RESORT
COMMERCIAL

SURFACE
RANGE &
TECHNICAL
SPECS



ENJOY
THE VIDEO





Space designed by
MARCO CASAMONTI / ARCHEA ASSOCIATI

FLOOR
Boost Icor
Bone

MOMENT

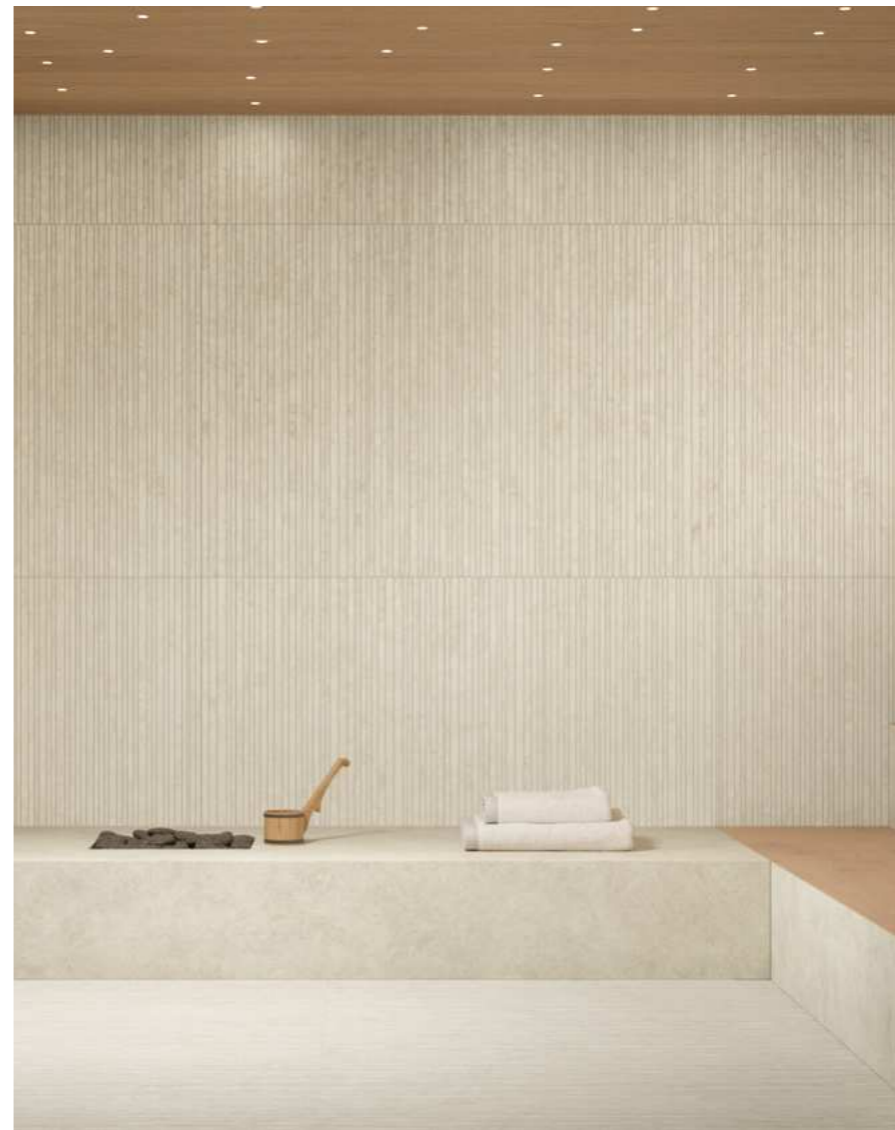

IN TIME

INDEX



INSPIRATION



ARCHEA X
ATLAS CONCORDE



IMAGE
GALLERY



LIVING VILLA WITH EXT.
LIVING KITCHEN
BATHROOM
VILLA WITH POOL
SPA
LOBBY RESORT
COMMERCIAL

SURFACE
RANGE &
TECHNICAL
SPECS



ENJOY
THE VIDEO



[INDEX](#)



[INSPIRATION](#)



[ARCHEA X
ATLAS CONCORDE](#)



[IMAGE
GALLERY](#)



LIVING VILLA WITH EXT.
LIVING KITCHEN
BATHROOM
VILLA WITH POOL
SPA
LOBBY RESORT
COMMERCIAL

[SURFACE
RANGE &
TECHNICAL
SPECS](#)



[ENJOY
THE VIDEO](#)



WALL
Boost Icor
Bone
Matte
120x278 (47¹/₄"x109¹/₂")

Boost Icor
Bone Railway
Matte Sensitech
60x120 (23⁵/₈"x47¹/₄")

Boost Icor
3D Masonry Bone
Matte
50x120 (19⁵/₈"x47¹/₄")

FLOOR
Boost Icor
Bone
Outdoor Sensitech ± 20 mm
120x120 (47¹/₄"x47¹/₄")

Boost Icor
Bone Round
Outdoor Sensitech ± 20 mm
33x120 (13"x47¹/₄")



<
OUTDOOR FLOOR
Boost Icor
Bone
 Outdoor Sensitech \pm 20 mm
 120x120 (47 $\frac{1}{4}$ "x47 $\frac{1}{4}$ ")

^
FLOOR
Boost Icor
Bone
 Outdoor Sensitech \pm 20mm
 120x120 (47 $\frac{1}{4}$ "x47 $\frac{1}{4}$ ")

^
WALL
Boost Icor
3D Masonry Bone
 Matte
 50x120 (19 $\frac{5}{8}$ "x47 $\frac{1}{4}$ ")

INDEX



INSPIRATION



ARCHEA X
ATLAS CONCORDE



IMAGE
GALLERY



LIVING VILLA WITH EXT.
LIVING KITCHEN
BATHROOM
VILLA WITH POOL
SPA
LOBBY RESORT
COMMERCIAL

SURFACE
RANGE &
TECHNICAL
SPECS



ENJOY
THE VIDEO





Space designed by
MARCO CASAMONTI / ARCHEA ASSOCIATI

FLOOR
Boost Icor
Sideral

QUIET



HOSPITALITY

INDEX



INSPIRATION



ARCHEA X
ATLAS CONCORDE



IMAGE
GALLERY



LIVING VILLA WITH EXT.
LIVING KITCHEN
BATHROOM
VILLA WITH POOL
SPA
LOBBY RESORT
COMMERCIAL

SURFACE
RANGE &
TECHNICAL
SPECS



ENJOY
THE VIDEO



INDEX



INSPIRATION



ARCHEA X
ATLAS CONCORDE



IMAGE
GALLERY



LIVING VILLA WITH EXT.
LIVING KITCHEN
BATHROOM
VILLA WITH POOL
SPA
LOBBY RESORT
COMMERCIAL

SURFACE
RANGE &
TECHNICAL
SPECS



ENJOY
THE VIDEO



INDOOR FLOOR
Boost Icor
Sideral
Matte Sensitech
120x120 (47¹/₄"x47¹/₄")

WALL
Boost Icor
Oyster
Matte
120x278 (47¹/₄"x109¹/₄")

OUTDOOR FLOOR
Boost Icor
Sideral
Outdoor Sensitech ± 20 mm
120x120 (47¹/₄"x47¹/₄")

COUNTERTOP
Atlas Plan
Boost Icor Bone
Hammered ± 12 mm
162x324 (63³/₄"x127¹/₂")

INDEX



INSPIRATION



ARCHEA X
ATLAS CONCORDE



IMAGE
GALLERY



LIVING VILLA WITH EXT.
LIVING KITCHEN
BATHROOM
VILLA WITH POOL
SPA
LOBBY RESORT
COMMERCIAL

SURFACE
RANGE &
TECHNICAL
SPECS



ENJOY
THE VIDEO

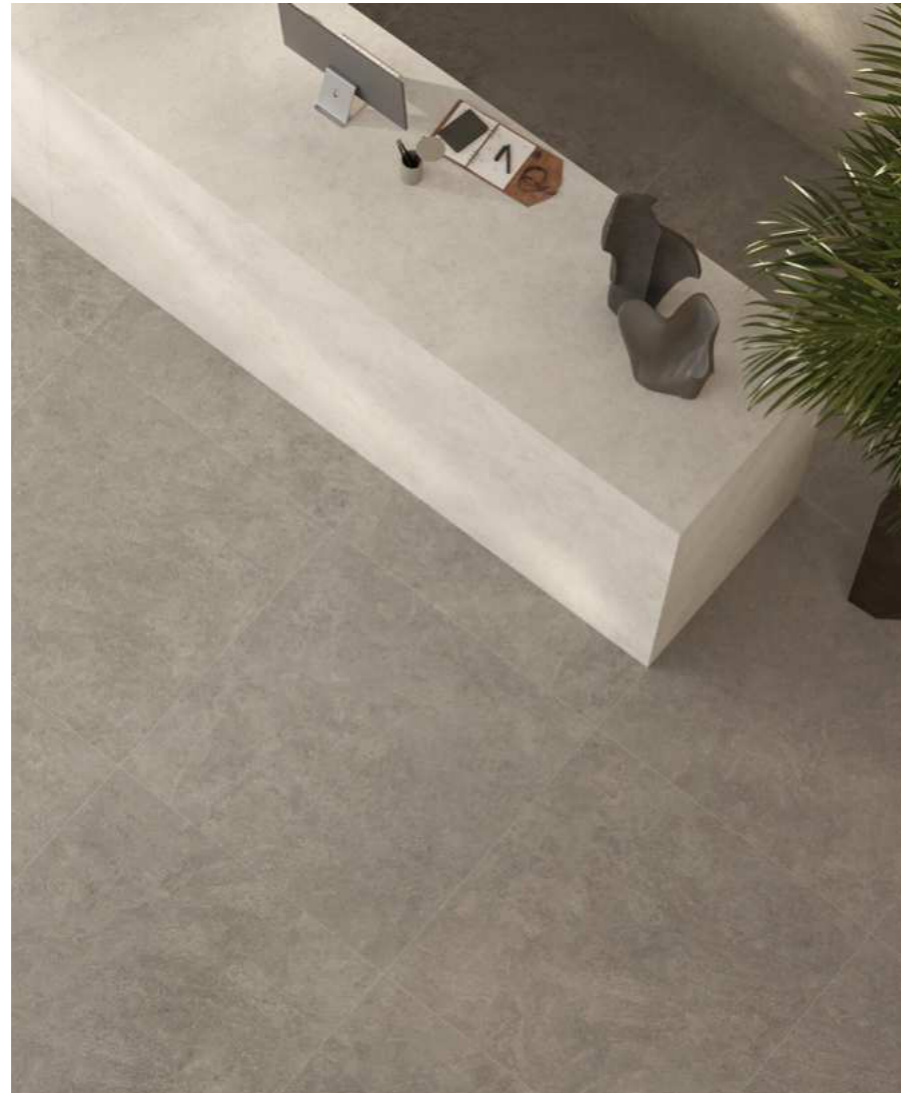

^
WALL
Boost Icor
Oyster Chevron
Matte
30,5x35,6 (1¹/₆₄"x12¹/₆₄"

^
FLOOR
Boost Icor
Sideral
Matte Sensitech
120x120 (47¹/₄"x47¹/₄"

^
WALL
Boost Icor
Oyster
Matte
120x278 (47¹/₄"x47¹/₄"





BRAND



ELEVATION

INDEX



INSPIRATION



ARCHEA X
ATLAS CONCORDE



IMAGE
GALLERY



LIVING VILLA WITH EXT.
LIVING KITCHEN
BATHROOM
VILLA WITH POOL
SPA
LOBBY RESORT
COMMERCIAL

SURFACE
RANGE &
TECHNICAL
SPECS



ENJOY
THE VIDEO



INDEX 

INSPIRATION 



ARCHEA X
ATLAS CONCORDE 

IMAGE
GALLERY 

LIVING VILLA WITH EXT.
LIVING KITCHEN
BATHROOM
VILLA WITH POOL
SPA
LOBBY RESORT
COMMERCIAL

SURFACE
RANGE &
TECHNICAL
SPECS 

ENJOY
THE VIDEO 



FLOOR
Boost Icor
Crete
Matte Sensitech
120x120 (47 1/4" x 47 1/4")

WALL
Boost Icor
Bone
Matte
120x278 (47 1/4" x 109 1/2")

Log
Icon Oak
Matte
120x278 (47 1/4" x 109 1/2")



INDEX



INSPIRATION



ARCHEA X
ATLAS CONCORDE



IMAGE
GALLERY



LIVING VILLA WITH EXT.
LIVING KITCHEN
BATHROOM
VILLA WITH POOL
SPA
LOBBY RESORT
COMMERCIAL

SURFACE
RANGE &
TECHNICAL
SPECS



ENJOY
THE VIDEO

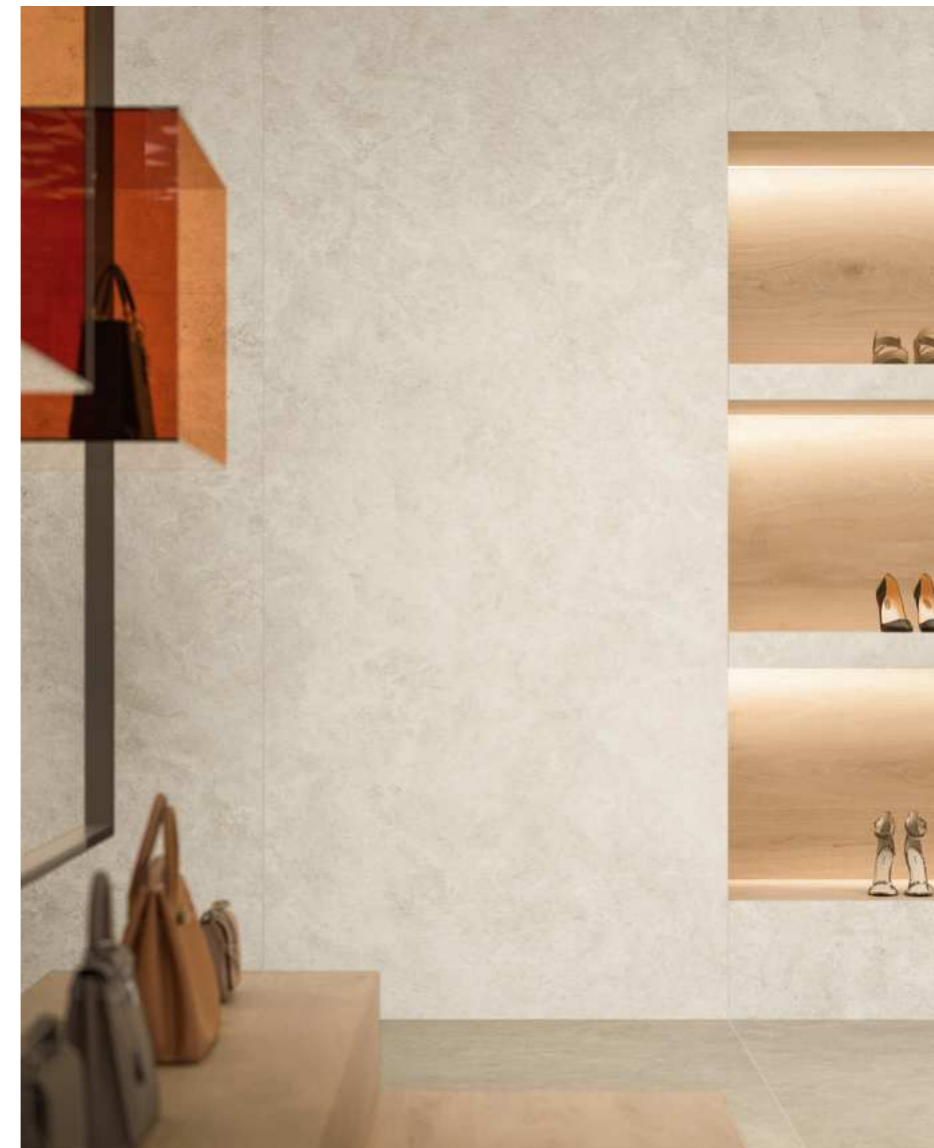

^
WALL
Boost Icor
Bone
Matte
120x278 (47¹/₄"x109¹/₂")

Log
Icon Oak
Matte
120x278 (47¹/₄"x109¹/₂")

<
FLOOR
Boost Icor
Crete
Matte Sensitech
120x120 (47¹/₄"x47¹/₄")

INDEX



INSPIRATION



ARCHEA X
ATLAS CONCORDE



IMAGE
GALLERY



SURFACE
RANGE &
TECHNICAL
SPECS



BOOST ICOR RANGE
SENSITECH TECHNOLOGY
TECHNICAL SPECIFICATIONS
BOOST WORLD

ENJOY
THE VIDEO



SURFACE RANGE &

- ◊ BOOST ICOR RANGE
- ◊ SENSITECH TECHNOLOGY
- ◊ TECHNICAL SPECIFICATIONS
- ◊ BOOST WORLD



TECHNICAL SPEC.

Porcelain tiles

PORCELAIN TILES - Gres Porcellanato - Grès cérame - Feinsteinzeug - Gres porcelánico - Керамический гранит
RECTIFIED MONOCALIBER - Rettificato monocalibro - Rectifié mono-calibre - Geschliffen einkalibrig - Rectificado monocalibre - Ретифицированный в одном калибре

		Bone	Dust	Dune	Crete	Oyster	Sideral
Floor							
Wall							
Bathroom furniture							
160x320 cm ** - 63 ³ / ₄ "x126"	± 6 mm	Hammered		Hammered			
120x278 cm - 47 ¹ / ₄ "x109 ¹ / ₂ "	± 6 mm	Matte	Matte	Matte		Matte	
120x240 cm - 47 ¹ / ₄ "x94 ¹ / ₂ "	± 9 mm	Matte Sensitech	Matte Sensitech	Matte Sensitech		Matte Sensitech	
75x150 cm - 29 ¹ / ₂ "x59"	± 9 mm	Matte Sensitech	Matte Sensitech	Matte Sensitech	Matte Sensitech	Matte Sensitech	Matte Sensitech
120x120 cm - 47 ¹ / ₄ "x47 ¹ / ₄ "	± 9 mm	Matte Sensitech	Matte Sensitech	Matte Sensitech	Matte Sensitech	Matte Sensitech	Matte Sensitech
60x120 cm - 23 ⁵ / ₈ "x47 ¹ / ₄ "	± 9 mm	Matte Sensitech	Matte Sensitech	Matte Sensitech	Matte Sensitech	Matte Sensitech	Matte Sensitech
60x60 cm - 23 ⁵ / ₈ "x23 ⁵ / ₈ "	± 9 mm	Matte Sensitech	Matte Sensitech	Matte Sensitech	Matte Sensitech	Matte Sensitech	Matte Sensitech
30x60 cm - 11 ³ / ₄ "x23 ⁵ / ₈ "	± 9 mm	Matte Sensitech	Matte Sensitech	Matte Sensitech	Matte Sensitech	Matte Sensitech	Matte Sensitech
60x120 cm Railway * - 23 ⁵ / ₈ "x47 ¹ / ₄ "	± 9 mm	Matte Sensitech					

Slabs for Countertops

162x324 cm ** - 63 ⁵ / ₈ "x127"	± 12 mm	Hammered		Hammered			
---	---------	----------	--	----------	--	--	--

› Non rectified - non rettificato

Outdoor

60x120 cm - 23 ⁵ / ₈ "x47 ¹ / ₄ "	± 9 mm	Grip Sensitech	Grip Sensitech	Grip Sensitech		Grip Sensitech	
30x60 cm - 11 ³ / ₄ "x23 ⁵ / ₈ "	± 9 mm	Grip Sensitech	Grip Sensitech	Grip Sensitech		Grip Sensitech	
120x120 cm - 47 ¹ / ₄ "x47 ¹ / ₄ "	± 20 mm	Outdoor Sensitech	Outdoor Sensitech	Outdoor Sensitech		Outdoor Sensitech	
60x120 cm - 23 ⁵ / ₈ "x47 ¹ / ₄ "	± 20 mm	Outdoor Sensitech	Outdoor Sensitech	Outdoor Sensitech		Outdoor Sensitech	
60x60 cm - 23 ⁵ / ₈ "x23 ⁵ / ₈ "	± 20 mm	Outdoor Sensitech	Outdoor Sensitech	Outdoor Sensitech		Outdoor Sensitech	
60x120 cm Railway * - 23 ⁵ / ₈ "x47 ¹ / ₄ "	± 9 mm	Grip Sensitech					

* Graphic decor. Misalignments in the continuity between different patterns is normal for this type of product. Decoro grafico. Eventuali disallineamenti nella continuità tra grafiche diverse sono una caratteristica intrinseca di questa tipologia di prodotto.

** Atlas Plan

Destination of use



Matte ± 6 mm



Matte Sensitech ± 9 mm
Grip Sensitech ± 9 mm
Outdoor Sensitech ± 20 mm

Anti-slip



R9 A Matte ± 6 mm
R10 A+B Matte Sensitech ± 9 mm
R11 C Grip Sensitech ± 9 mm
R11 C Outdoor Sensitech ± 20 mm

Color-shading

V3 Moderate Variation
All colors

Wall tiles

WALL TILES - Rivestimenti - Revêtements - Wandfliesen - Revestimientos - Настенная плитка
RECTIFIED MONOCALIBER - Rettificato monocalibro - Rectifié mono-calibre - Geschliffen einkalibrig - Rectificado monocalibre - Ретифицированный в одном калибре

		Bone	Dust
Wall			
50x120 cm - 19 ⁵ / ₈ "x47 ¹ / ₄ " Field	± 8,5 mm	Matte	Matte
50x120 cm - 19 ⁵ / ₈ "x47 ¹ / ₄ " 3D Wheat	± 10 mm	Matte	Matte
50x120 cm - 19 ⁵ / ₈ "x47 ¹ / ₄ " 3D Masonry	± 10 mm	Matte	Matte

V3 Moderate Variation
All colors



BONE



DUST



DUNE



CRETE



OYSTER

SIDERAL



3D Masonry

V3 Moderate Variation
All colors

WALL TILES - Rivestimenti - Revêtements - Wandfliesen - Revestimientos - Настенная плитка
RECTIFIED MONOCALIBER - Rettificato monocalibro - Rectifié mono-calibre - Geschliffen einkalibrig - Rectificado monocalibre - Ретифицированный в одном калибре



50x120 cm
19 7/8" x 47 1/4"
± 10 mm



Boost Icor 3D Masonry
Bone
50x120 cm (19 7/8" x 47 1/4")
± 10 mm

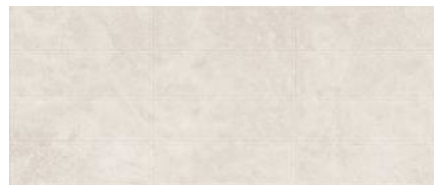

Boost Icor 3D Masonry Dust
Dust
50x120 cm (19 7/8" x 47 1/4")
± 10 mm

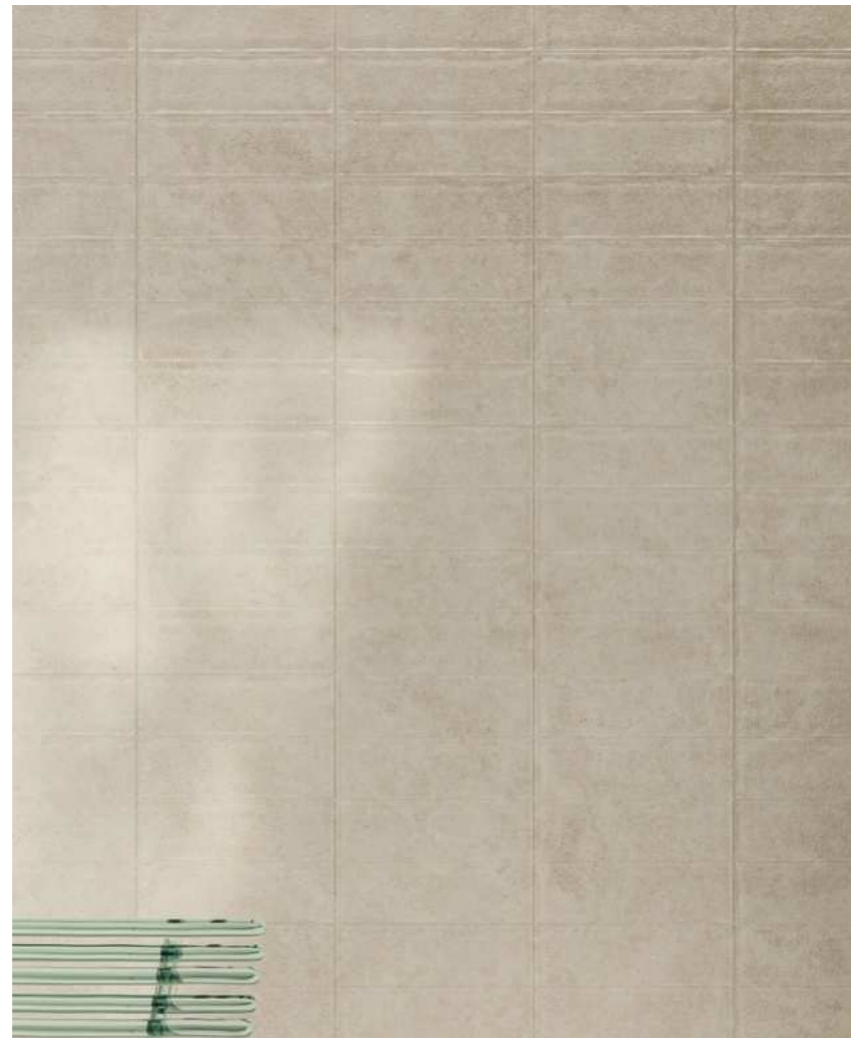

3D Wheat

V3 Moderate Variation
All colors

WALL TILES - Rivestimenti - Revêtements - Wandfliesen - Revestimientos - Настенная плитка
RECTIFIED MONOCALIBER - Rettificato monocalibro - Rectifié mono-calibre - Geschliffen einkalibrig - Rectificado monocalibre - Ретифицированный в одном калибре



50x120 cm
19 7/8" x 47 1/4"
± 10 mm

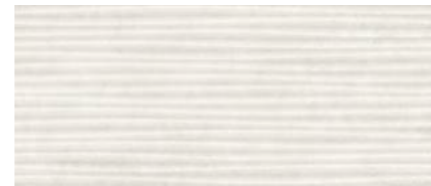

Boost Icor 3D Wheat
Bone
50x120 cm (19 7/8" x 47 1/4")
± 10 mm



Boost Icor 3D Wheat
Dust
50x120 cm (19 7/8" x 47 1/4")
± 10 mm



INDEX



INSPIRATION



ARCHEA X
ATLAS CONCORDE



IMAGE
GALLERY



SURFACE
RANGE &
TECHNICAL
SPECS



BOOST ICOR RANGE
SENSITECH TECHNOLOGY
TECHNICAL SPECIFICATIONS
BOOST WORLD

ENJOY
THE VIDEO



Mosaico Chevron

PORCELAIN TILES – Gres porcellanato – Grès cérame – Feinsteinzeug – Gres porcelánico – Керамический гранит

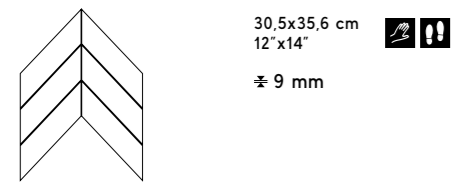

30,5x35,6 cm
12"x14"
± 9 mm

V3 Moderate Variation
All colors



Boost Icor Mosaico Chevron Bone 30,5x35,6 cm (12"x14")
 Boost Icor Mosaico Chevron Dust 30,5x35,6 cm (12"x14")
 Boost Icor Mosaico Chevron Dune 30,5x35,6 cm (12"x14")
 Boost Icor Mosaico Chevron Crete 30,5x35,6 cm (12"x14")
 Boost Icor Mosaico Chevron Oyster 30,5x35,6 cm (12"x14")
 Boost Icor Mosaico Chevron Sideral 30,5x35,6 cm (12"x14")



Mosaico Furnace

PORCELAIN TILES – Gres porcellanato – Grès cérame – Feinsteinzeug – Gres porcelánico – Керамический гранит

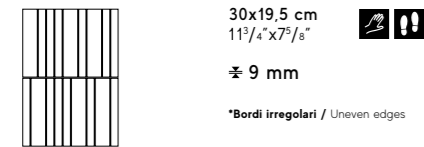

30x19,5 cm
11 3/4"x7 5/8"
± 9 mm
*Bordi irregolari / Uneven edges

V3 Moderate Variation
All colors



Boost Icor Mosaico Furnace Bone 30x19,5 cm (11 3/4"x7 5/8")
 Boost Icor Mosaico Furnace Dust 30x19,5 cm (11 3/4"x7 5/8")
 Boost Icor Mosaico Furnace Dune 30x19,5 cm (11 3/4"x7 5/8")
 Boost Icor Mosaico Furnace Crete 30x19,5 cm (11 3/4"x7 5/8")
 Boost Icor Mosaico Furnace Oyster 30x19,5 cm (11 3/4"x7 5/8")
 Boost Icor Mosaico Furnace Sideral 30x19,5 cm (11 3/4"x7 5/8")

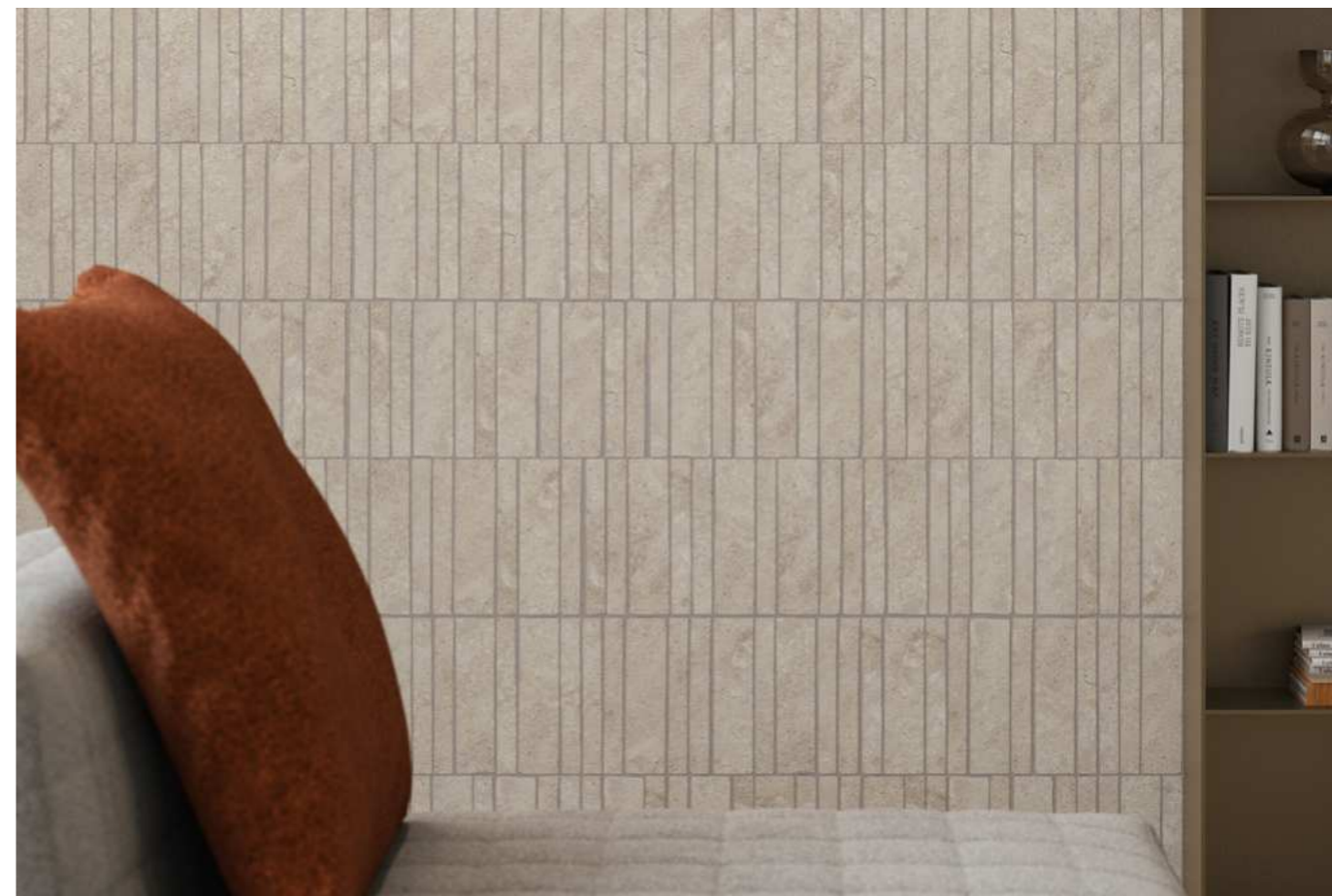

INDEX



INSPIRATION



ARCHEA X
ATLAS CONCORDE



IMAGE
GALLERY



SURFACE
RANGE &
TECHNICAL
SPECS



BOOST ICOR RANGE
SENSITECH TECHNOLOGY
TECHNICAL SPECIFICATIONS
BOOST WORLD

ENJOY
THE VIDEO



Pebble A+B - 9 mm Grip **Sensitech**

PORCELAIN TILES – Gres porcellanato - Grès cérame - Feinsteinzeug - Gres porcelánico - Керамический гранит

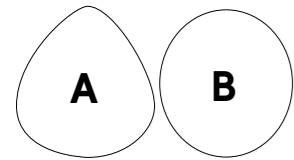

59,5x59,5 cm
23³/₈"x23³/₈"

± 9 mm

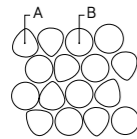

Pebble A: 0.259 m²
Pebble B: 0.252 m²

V3 Moderate Variation
All colors



Boost Icor Pebble A+B

Bone
59,5x59,5 cm - 23³/₈"x23³/₈"
Grip **Sensitech**

± 9 mm

Outdoor **Sensitech**

± 20 mm



Boost Icor Pebble A+B

Dust
59,5x59,5 cm - 23³/₈"x23³/₈"
Grip **Sensitech**

± 9 mm

Outdoor **Sensitech**

± 20 mm



Boost Icor Pebble A+B

Dune
59,5x59,5 cm - 23³/₈"x23³/₈"
Grip **Sensitech**

± 9 mm

Outdoor **Sensitech**

± 20 mm



Boost Icor Pebble A+B

Oyster
59,5x59,5 cm - 23³/₈"x23³/₈"
Grip **Sensitech**

± 9 mm

Outdoor **Sensitech**

± 20 mm

V3 Moderate Variation
All colors

Pebble A+B - 20 mm Outdoor **Sensitech**

PORCELAIN TILES – Gres porcellanato - Grès cérame - Feinsteinzeug - Gres porcelánico - Керамический гранит

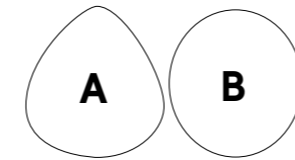

59,5x59,5 cm
23³/₈"x23³/₈"

± 20 mm

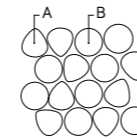

Pebble A: 0.259 m²
Pebble B: 0.252 m²



INDEX



INSPIRATION



ARCHEA X
ATLAS CONCORDE



IMAGE
GALLERY



SURFACE
RANGE &
TECHNICAL
SPECS



BOOST ICOR RANGE
SENSITECH TECHNOLOGY
TECHNICAL SPECIFICATIONS
BOOST WORLD

ENJOY
THE VIDEO



Combo A+B - 20 mm Outdoor Sensitech

PORCELAIN TILES - Gres porcellanato - Grès cérame - Feinsteinzeug - Gres porcelánico - Керамический гранит

V3 Moderate Variation
All colors

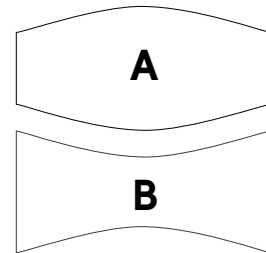

Combo A
48,4x119 cm
19 1/8"x46 7/8"
± 20 mm

Combo B
42,5x119 cm
16 3/4"x46 7/8"
± 20 mm

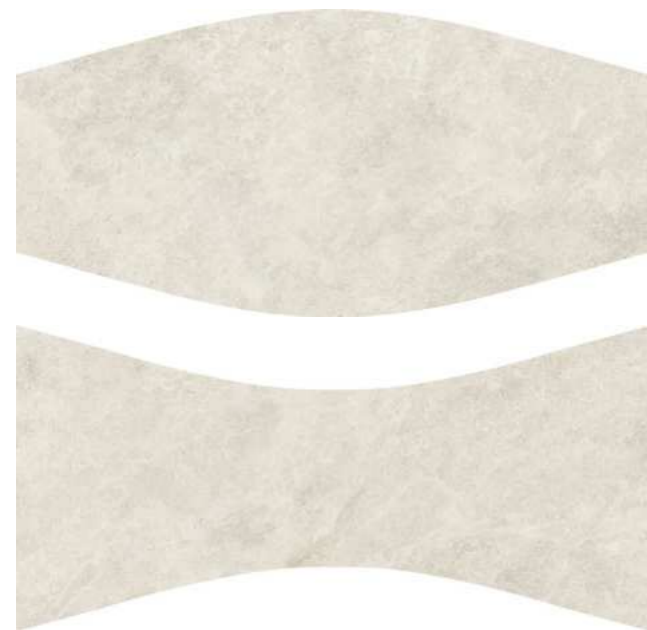

Boost Icor Combo A+B
Bone
Outdoor Sensitech



Boost Icor Combo A+B
Dust
Outdoor Sensitech

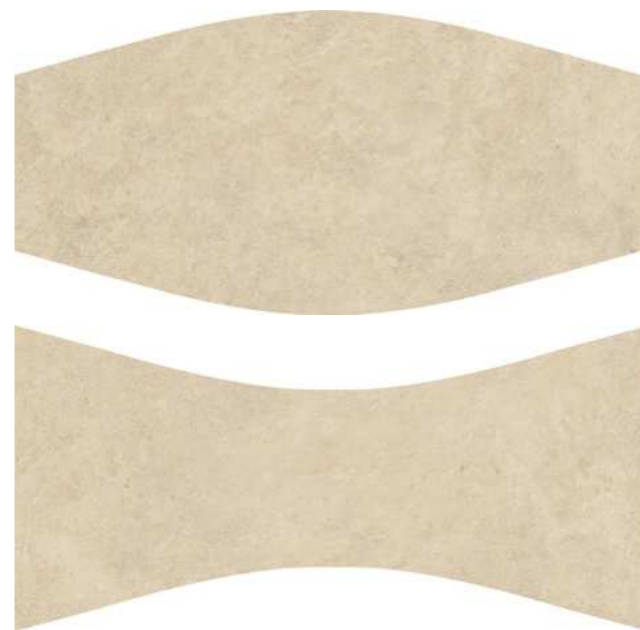

Boost Icor Combo A+B
Dune
Outdoor Sensitech



Boost Icor Combo A+B
Oyster
Outdoor Sensitech



INDEX



INSPIRATION



ARCHEA X
ATLAS CONCORDE



IMAGE
GALLERY



SURFACE
RANGE &
TECHNICAL
SPECS



BOOST ICOR RANGE
SENSITECH TECHNOLOGY
TECHNICAL SPECIFICATIONS
BOOST WORLD

ENJOY
THE VIDEO



Trim tiles

Porcelain trim tiles

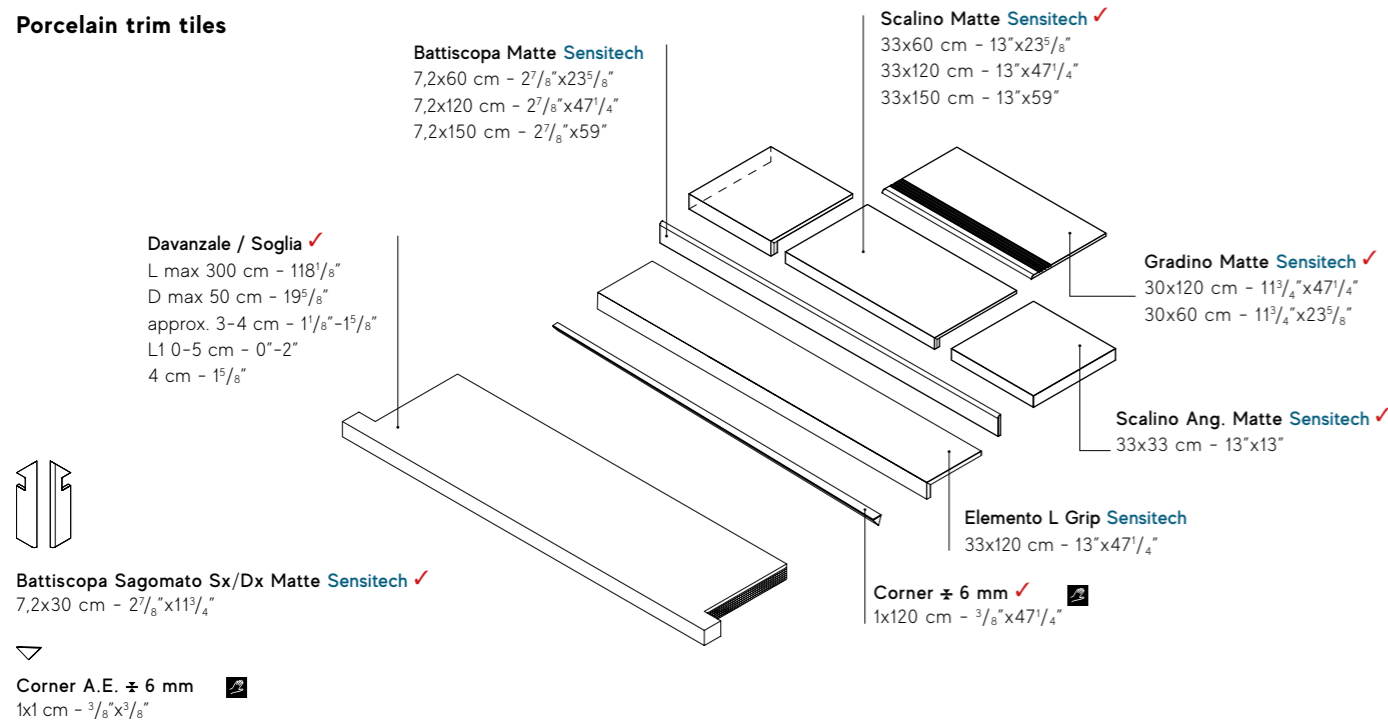

✓ These parts are supplied to order / I pezzi sono disponibili su ordinazione

Wall trim tiles

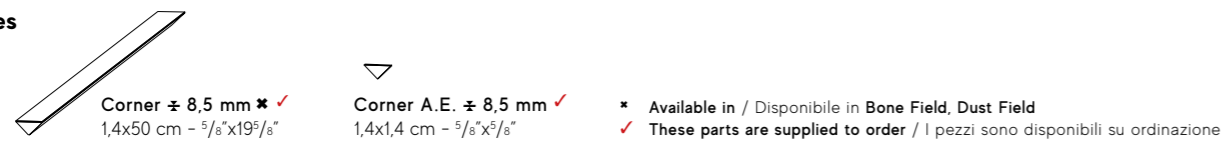

Outdoor trim tiles ± 20 mm

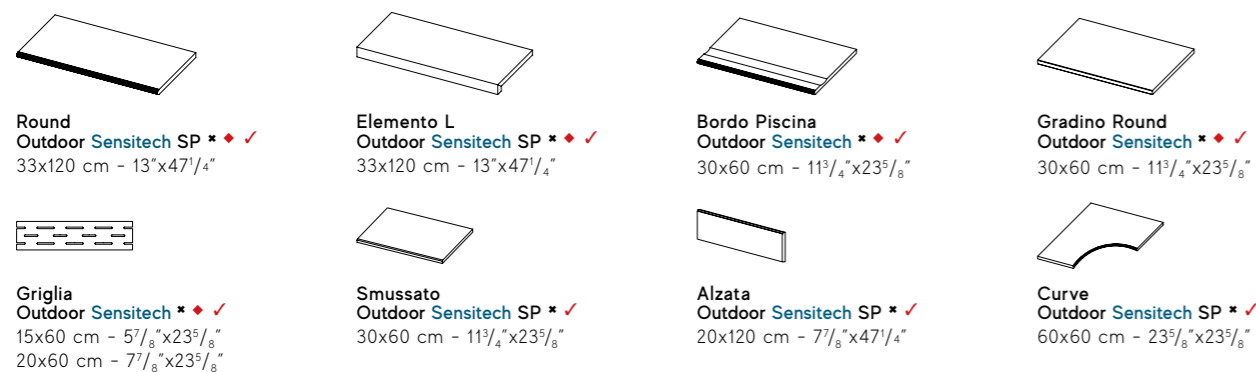

* Available in / Disponibile in Dust, Bone, Dune, Oyster
✓ These parts are supplied to order / I pezzi sono disponibili su ordinazione
◆ Right-left angular elements are available / Sono disponibili gli elementi angolari dx/sx

Outdoor Porcelain tiles ± 20 mm

For further details on the 20mm thick products, related trim pieces and installation systems - in particular for recommendations and precautions during installation- please refer to the Outdoor Design section on the Atlas Concorde website or to the Outdoor Design catalogue. Per dettagli sul prodotto e sui relativi pezzi speciali in 20mm di spessore, per i sistemi di posa e, in particolare, per raccomandazioni, accorgimenti e precauzioni in fase di posa e progettazione, si raccomanda di prendere visione del catalogo Outdoor Design e della sezione Outdoor Design del sito Atlas Concorde.

Sensitech

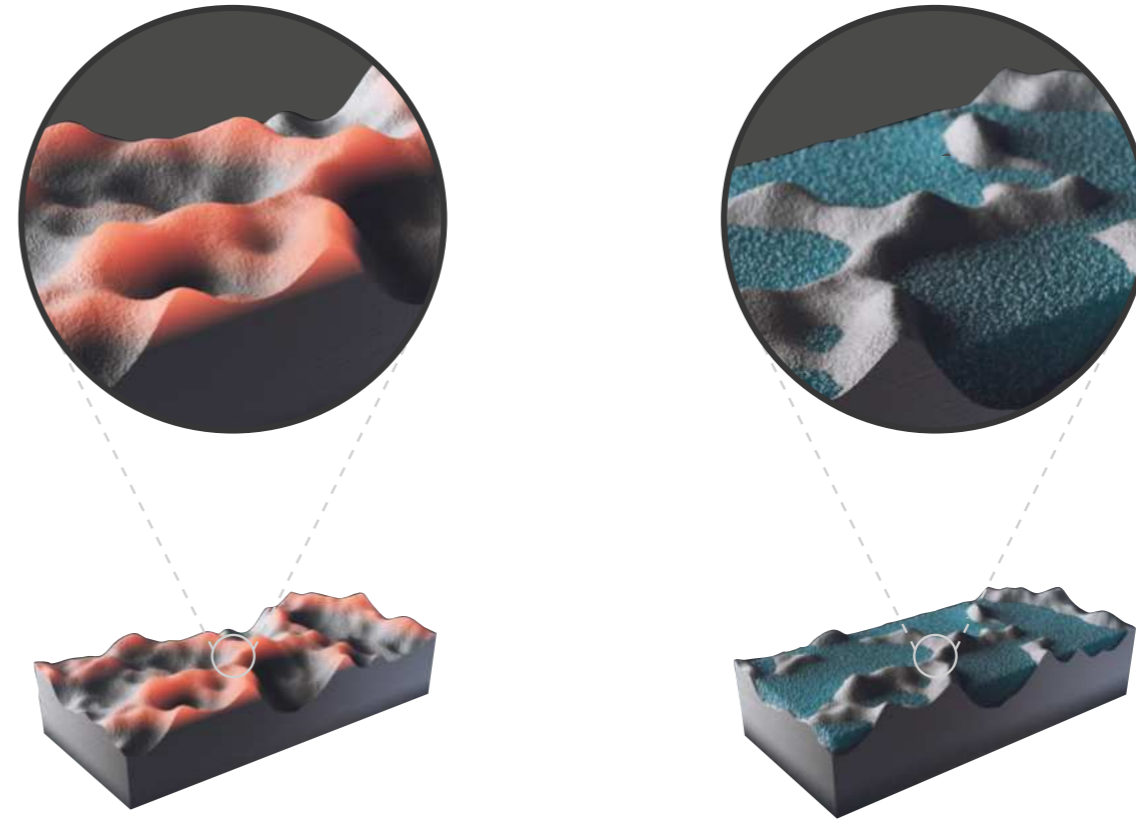

Traditional anti-slip surface

The innovative Sensitech Surface

Sensitech is the high-tech surface for indoor and outdoor settings created by Atlas Concorde Laboratories, patented in Europe. The surface combines high slip resistance performance with tactile softness. With Sensitech, the meaning of surface evolves and takes on a reassuring, pleasant and practical touch, making architectural spaces more comfortable and appealing.

Sensitech è la superficie ad alto coefficiente tecnologico per gli ambienti interni ed esterni realizzata dai Laboratori Atlas Concorde, brevettata in Europa. La superficie coniuga elevate prestazioni di resistenza allo scivolamento ad una maggiore morbidezza tattile. Con Sensitech il significato di superficie si evolve e assume un tocco rassicurante, piacevole e pratico, rendendo gli spazi architettonici sempre più confortevoli e appaganti.

MORE INFORMATION



Note

For information and details relating to codes, packaging and weight it is recommended to refer to the latest pricelist. - Per le informazioni e i dati relativi a codici, imballaggi e pesi occorre sempre consultare l'ultimo listino aggiornato e in vigore. - Pour toutes informations et renseignements concernant les codes, les emballages et les poids, il y a toujours lieu de consulter le dernier tarif en vigueur et mis à jour. - Für Informationen und Daten die den Code, die Verpackung und das Gewicht betreffen bitte die aktuellste Preisliste zugrunde legen. - Para acceder a la información y a los datos relativos a códigos, embalajes y pesos hay que consultar siempre la última lista de precios actualizada y vigente. - Для информации о кодах, упаковках и весе обращайтесь к последнему действующему прайс-листу.

Colors and optical features of the materials illustrated in this catalogue are to be regarded as mere indications. - I colori e le caratteristiche estetiche dei materiali illustrati nel presente catalogo sono da ritenersi puramente indicativi. - Les coloris et les caractéristiques esthétiques des références illustrées dans le catalogue sont donnés à titre purement indicatif. - Die Farben und die ästhetischen Eigenschaften der in diesem Katalog abgebildeten Produkte sind als reine Richtwerte zu betrachten. - Los colores y las características estéticas de los materiales ilustrados en el presente catálogo deben ser considerados como puramente indicativos. - Цвета и эстетические характеристики описанных в настоящем каталоге материалов являются только ориентировочными.

Atlas Concorde reserves the right to modify any product without notice and will not be liable for any direct or indirect damage resulting from such modifications. - Atlas Concorde si riserva di modificare i prodotti senza preavviso, declinando ogni responsabilità su eventuali danni diretti o indiretti derivanti da eventuali modifiche. - Atlas Concorde se réserve le droit de modifier ses produits sans préavis et décline toute responsabilité concernant les éventuels dommages directs ou indirects qui pourraient dériver de ces modifications. - Atlas Concorde behält sich das Recht vor jederzeit und ohne vorherige Ankündigung, die Produkte zu verändern, und lehnt jede Haftung bei direkten oder indirekten Schäden ab, die von diesen Veränderungen herrühren. - Atlas Concorde se reserva el derecho de modificar los productos sin previo aviso, rechaza cualquier responsabilidad sobre eventuales daños directos o indirectos derivados de eventuales modificaciones. - Atlas Concorde оставляет за собой право изменять характеристики изделий без предварительного уведомления, отклоняя при этом любую ответственность за прямые или косвенные убытки, возникшие в результате изменений.

INDEX



INSPIRATION



ARCHEA X
ATLAS CONCORDE



IMAGE
GALLERY



SURFACE
RANGE &
TECHNICAL
SPECS



BOOST ICOR RANGE
SENSITECH TECHNOLOGY
TECHNICAL SPECIFICATIONS
BOOST WORLD

ENJOY
THE VIDEO



Porcelain tiles - Rectified monocaliber

Gres porcellanato - Rettificato monocalibro

Compliant with standards EN 14411 annex G group B1a
 Compliant with standards ISO 13006 annex G group B1a
 Conforme alla norma EN 14411 Appendice G gruppo B1a
 Conforme alla norma ISO 13006 Appendice G gruppo B1a

160x320 cm - 63 ¹ / ₈ "x126"	± 6 mm	60x60 cm - 23 ⁵ / ₈ "x23 ⁵ / ₈ "	± 9 mm
120x278 cm - 47 ¹ / ₈ "x109 ¹ / ₂ "	± 6 mm	30x60 cm - 11 ¹ / ₈ "x23 ⁵ / ₈ "	± 9 mm
120x240 cm - 47 ¹ / ₈ "x94 ¹ / ₂ "	± 9 mm	16x2324 cm - 63 ¹ / ₈ "x127"	± 12 mm
75x50 cm - 29 ¹ / ₂ "x59"	± 9 mm	120x120 cm - 47 ¹ / ₈ "x47 ¹ / ₈ "	± 20 mm
120x120 cm - 47 ¹ / ₈ "x47 ¹ / ₈ "	± 9 mm	60x120 cm - 23 ⁵ / ₈ "x47 ¹ / ₈ "	± 20 mm
60x120 cm - 23 ⁵ / ₈ "x47 ¹ / ₈ "	± 9 mm	60x60 cm - 23 ⁵ / ₈ "x23 ⁵ / ₈ "	± 20 mm



Technical features Caratteristiche tecniche	Test Method Metodo di prova	Requirements for nominal size N Requisiti per dimensione nominale N				Porcelain tiles			
		7 cm ≤ N < 15 cm		N ≥ 15 cm		Matte ± 6 mm	Matte Sensitech ± 9 mm	Grip Sensitech ± 9 mm	Outdoor Sensitech ± 20 mm
		(mm)	(%)	(mm)	(mm)				
Length and width Lunghezza e larghezza	ISO 10545-2	± 0,9 (*) Non-rect. ± 0,4 (*) Rect.	± 0,6 (*) Non-rect. ± 0,3 (*) Rect.	± 2,0 (*) Non-rect. ± 1,0 (*) Rect.	Suitable for Conforme	Suitable for Conforme	Suitable for Conforme	Suitable for Conforme	
Thickness Spessore		± 0,5 (**)	± 5 (**)	± 0,5 (**)	Suitable for Conforme	Suitable for Conforme	Suitable for Conforme	Suitable for Conforme	
Straightness of sides Rettilinearità degli spigoli		± 0,8 (***) Non-rect. ± 0,4 (***) Rect.	± 0,5 (***) Non-rect. ± 0,3 (***) Rect.	± 1,5 (***) Non-rect. ± 0,8 (***) Rect.	Suitable for Conforme	Suitable for Conforme	Suitable for Conforme	Suitable for Conforme	
Rectangularity Ortogonalità	ISO 10545-2	± 0,8 (***) Non-rect. ± 0,4 (***) Rect.	± 0,5 (***) Non-rect. ± 0,3 (***) Rect.	± 2,0 (***) Non-rect. ± 1,5 (***) Rect.	Suitable for Conforme	Suitable for Conforme	Suitable for Conforme	Suitable for Conforme	
Surface flatness Planarità		c.c. ± 0,8 Non-rect. c.c. ± 0,6 Rect.	c.c. ± 0,5 Non-rect. c.c. ± 0,4 Rect.	c.c. ± 2,0 Non-rect. c.c. ± 1,8 Rect.	Suitable for Conforme	Suitable for Conforme	Suitable for Conforme	Suitable for Conforme	
Water absorption (in % by mass) Massa d'acqua assorbita (come % della massa)		ISO 10545-3 ASTM C373	E _v ≤ 0,5% Individual Maximum 0,6% E _v ≤ 0,5% Valore massimo singolo 0,6%		Requirement ANSI A137.1-2017 Water absorption max ≤ 0,5%	≤ 0,1%	≤ 0,1%	≤ 0,1%	≤ 0,1%
Breaking strength Sforzo di rottura	ISO 10545-4	S ≥ 700N (for thickness < 7,5 mm - per spessore < 7,5 mm) S ≥ 1300N (for thickness ≥ 7,5 mm - per spessore ≥ 7,5 mm)		≤ 0,5%	≤ 0,5%	≤ 0,5%	≤ 0,5%		
Modulus of rupture Resistenza alla flessione		R ≥ 35 N/mm ²		R≥40 N/mm ²	R≥40 N/mm ²	R≥40 N/mm ²	R≥45 N/mm ²		
Bending strength and breaking load Resistenza a flessione e al carico di rottura (4)(5)	EN 1339 Annex F	-		-	-	-	-		
Impact resistance, as coefficient of restitution Resistenza all'impatto, espresso come coefficiente di restituzione	ISO 10545-5	Declared value Valore dichiarato		≥0,55	≥0,55	≥0,55	≥0,55		
Resistance to deep abrasion of unglazed tiles (removed volume) Resistenza all'abrasione profonda delle piastrelle non smaltate (volume materiale asportato)	ISO 10545-6	≤ 175 mm ³		≤150mm ³	≤150mm ³	≤150mm ³	≤150mm ³		
Coefficient of thermal linear expansion Coefficiente di dilatazione termica lineare	ISO 10545-8	Declared value Valore dichiarato		≤7MK ⁻¹	≤7MK ⁻¹	≤7MK ⁻¹	≤7MK ⁻¹		
Thermal shock resistance Resistenza agli sbalzi termici	ISO 10545-9	Pass according to EN ISO 10545-1 Test superato in accordo con ISO 10545-1		Resistant Resiste	Resistant Resiste	Resistant Resiste	Resistant Resiste		
Moisture expansion (in mm/m) Dilatazione all'umidità (in mm/m)	ISO 10545-10	Declared value Valore dichiarato		≤ 0,01% (0,1mm/m)	≤ 0,01% (0,1mm/m)	≤ 0,01% (0,1mm/m)	≤ 0,01% (0,1mm/m)		
Frost resistance Resistenza al gelo	ISO 10545-12	Pass according to EN ISO 10545-1 Test superato in accordo con ISO 10545-1		Resistant Resiste	Resistant Resiste	Resistant Resiste	Resistant Resiste		
Bond strength/adhesion for Cementitious Adhesives Adesione mediante trazione su adesivi cementizi	EN 12004-2	Declared value Valore dichiarato		≥ 1,0 N/mm ² (Class C2 - EN 12004)	≥ 1,0 N/mm ² (Class C2 - EN 12004)	≥ 1,0 N/mm ² (Class C2 - EN 12004)	≥ 1,0 N/mm ² (Class C2 - EN 12004)		
Reaction to fire Reazione al fuoco	-	Class A1 or A1 _{fl} Classe A1 oppure A1 _{fl}		A1 - A1 _{fl}	A1 - A1 _{fl}	A1 - A1 _{fl}	A1 - A1 _{fl}		
Resistance to household chemicals and swimming pool salts Resistenza ai prodotti chimici di uso domestico e agli additivi per piscina	ISO 10545-13	Minimum Class B Classe minima B		A	A	A	A		
Resistance to low concentrations of acids and alkalis Resistenza a basse concentrazioni di acidi e alcali		Declared Class Classe dichiarata		LA	LA	LA	LA		
Resistance to high concentrations of acids and alkalis Resistenza ad alte concentrazioni di acidi e alcali		Declared Class Classe dichiarata		HA	HA	HA	HA		
Resistance to staining, for unglazed tiles Resistenza alle macchie per piastrelle non smaltate	ISO 10545-14	Declared Class Classe dichiarata		5	5	5	5		
Shod Ramp Test Metodo della rampa "calzato"	DIN EN 16165 ANNEX B (EX DIN 51130)	Declared value Valore dichiarato		R9	R10	R11	R11		
Barefoot Ramp Test Metodo della rampa a piedi nudi	DIN EN 16165 ANNEX A (EX DIN 51097)	Declared value Valore dichiarato		A	A+B	A+B+C	A+B+C		
Pendulum Friction Test Metodo del Pendolo	BS EN 16165 ANNEX C (EX BS 7976)	PTV ≥ 36 classifies the surface as "low slip risk"		(●)	≥ 36 Dry ≥ 36 Wet	≥ 36 Dry ≥ 36 Wet	≥ 36 Dry ≥ 36 Wet		
	AS 4586	Declared Classification of the new pedestrian surface materials according to the Pendulum Test		(●●)	Class P3	Class P4	Class P4		
	UNE EN 16165 ANNEX C (EX UNE 41901 EX2017)	Declared value Valore dichiarato		(●●●)	Class C2	Class C3	Class C3		
Coefficient of friction (COF) Coefficiente di attrito	B.C.R.A. Rep. CEC/81	D. M. 236/89 del 14/06/89 μ > 0,40 per elemento scivolante cuolo su pavimentazione asciutta μ > 0,40 per elemento scivolante gomma dura su pavimentazione bagnata		> 0,40 Asciutto > 0,40 Bagnato	> 0,40 Asciutto > 0,40 Bagnato	> 0,40 Asciutto > 0,40 Bagnato	> 0,40 Asciutto > 0,40 Bagnato		
Dynamic coefficient of friction (DCOF) Coefficiente di attrito dinamico	ANSI A 326.3	-		wet DCOF ≥ 0,42	wet DCOF ≥ 0,50	wet DCOF ≥ 0,55	dry DCOF ≥ 0,55		

(*) The permissible deviation, in % or mm, of the average size for each tile (2 or 4 sides) from work size (WS). Deviazione ammissibile, in % oppure mm, della dimensione media di ogni piastrella (2 oppure 4 lati) dalla dimensione di fabbricazione (WS).
 (**) The permissible deviation, in % or mm, of the average thickness for each tile from the work size thickness (WS). Deviazione ammissibile, in % oppure mm, della spessore medio di ogni piastrella dallo spessore riportato nella dimensione di fabbricazione (WS).
 (***) The maximum permissible deviation from straightness, in % or mm, related to the corresponding work sizes (WS). Deviazione massima ammissibile di rettilineità, in % oppure mm, in rapporto alle dimensioni di fabbricazione (WS) corrispondenti.
 (****) The maximum permissible deviation from rectangularity, in % or mm, related to the corresponding work sizes (WS). Deviazione massima ammissibile di ortogonalità, in % oppure mm, in rapporto alle dimensioni di fabbricazione (WS) corrispondenti.
 c.c. The maximum permissible deviation from centre curvature, in % or mm, related to diagonal calculated from the work sizes (WS). Deviazione massima ammissibile della curvatura del centro, in % oppure mm, in rapporto alla diagonale calcolata secondo le dimensioni di fabbricazione (WS).
 e.c. The maximum permissible deviation from edge curvature, in % or mm, related to the corresponding work sizes (WS). Deviazione massima ammissibile della curvatura dello spigolo, in % oppure mm, in rapporto alle dimensioni di fabbricazione (WS) corrispondenti.
 w. The maximum permissible deviation from warpage, in % or mm, related to diagonal calculated from the work sizes (WS). Deviazione massima ammissibile dello sverglamento, in % oppure mm, in rapporto alla diagonale calcolata secondo le dimensioni di fabbricazione (WS).
 (1) Determination of slip resistance of pedestrian surfaces; it does not cover sports surfaces and road surfaces for vehicles (kid resistance). Determinazione della resistenza allo scivolamento delle superfici pedonabili; non si applica alle pavimentazioni sportive ed alle pavimentazioni stradali veicolari.
 (2) Anti-slip performance is guaranteed at the time of delivery of the product. Le prestazioni anti-slip vengono garantite al momento della consegna del prodotto.
 (3) For further details, please refer to outdoor design general catalogue. Per maggiori informazioni riferirsi al catalogo generale Outdoor Design.
 (4) Only for products with 20 mm thickness. Solo per prodotti a 20mm di spessore.
 (5) PTV ≥ 36 Wet on demand / su richiesta (●●) P3 on demand / su richiesta (●●●) C2 on demand / su richiesta



Wall tiles - Rectified monocaliber

Rivestimento - Rettificato monocalibro

Compliant with standards EN 14411 annex L group B11
 Compliant with standards ISO 13006 annex L group B11
 Conforme alla norma EN 14411 Appendice L gruppo B11
 Conforme alla norma ISO 13006 Appendice L gruppo B11

50x120 cm - 19 ⁵ / ₈ "x47 ¹ / ₈ "	± 8,5 mm	Matte
50x120 cm - 19 ⁵ / ₈ "x47 ¹ / ₈ "	± 10 mm	Matte

Technical features Caratteristiche tecniche	Test Method Metodo di prova	Requirements for nominal size N Requisiti per dimensione nominale N			Wall tiles	
		7 cm ≤ N < 15 cm		N ≥ 15 cm		
		(mm)	(%)	(mm)		
Length and width Lunghezza e larghezza	ISO 10545-2	± 0,4 (*) Rect.	± 0,3 (*) Rect.	± 1,0 (*) Rect.	Suitable for Conforme	
Thickness Spessore		± 0,5 (**)	± 10 (**)	± 0,5 (**)	Suitable for Conforme	
Straightness of sides Rettilinearità degli spigoli		± 0,4 (***) Rect.	± 0,3 (***) Rect.	± 0,8 (***) Rect.	Suitable for Conforme	
Rectangularity Ortogonalità		± 0,4 (****) Rect.	± 0,3 (****) Rect.	± 1,5 (****) Rect.	Suitable for Conforme	
Surface flatness Planarità	ISO 10545-2	c.c. ± 0,6 Rect.	c.c. ± 0,4 Rect.	c.c. ± 1,8 Rect.	Suitable for Conforme	
		e.c. ± 0,6 Rect.	e.c. ± 0,4 Rect.	e.c. ± 1,8 Rect.		
		w. ± 0,6 Rect.	w. ± 0,4 Rect.	w. ± 1,8 Rect.		
Water absorption (in % by mass) Massa d'acqua assorbita (come % della massa)	ISO 10545-3	Average >10%. When the average > 20%, this shall be indicated. Individual value > 9% Media >10%. Se questo valore > 20%, deve essere indicato. Valore Singolo > 9%			10% < E _v ≤ 20%	
Breaking strength Sforzo di rottura	ISO 10545-4	S ≥ 600 N			S ≥ 600 N	
Modulus of rupture Resistenza alla flessione		R ≥ 15 N/mm ²			R ≥ 15 N/mm ²	
Coefficient of thermal linear expansion Coefficiente di dilatazione termica lineare	ISO 10545-8	Declared value Valore dichiarato			≤ 7MK ⁻¹	
Thermal shock resistance Resistenza agli sbalzi termici	ISO 10545-9	Pass according to EN ISO 10545-1 Test superato in accordo con ISO 10545-1			Resistant Resiste	
Moisture expansion (in mm/m) Dilatazione all'umidità (in mm/m)	ISO 10545-10	Declared value Valore dichiarato			≤ 0,06% (0,6mm/m)	
Crazing resistance Resistenza al cavillo	ISO 10545-11	Pass according to EN ISO 10545-1 Test superato in accordo con ISO 10545-1			Resistant Resiste	
Bond strength/adhesion for improved cementitious adhesives Adesione a trazione con adesivi cementizi migliorati	EN 1348	Declared value Valore dichiarato			≥ 1,0 N/mm ² (Class C2 - EN 12004)	
Reaction to fire Reazione al fuoco	-	Class A1 Classe A1			A1	
Resistance to household chemicals and swimming pool salts Resistenza ai prodotti chimici di uso domestico ed agli additivi per piscina	ISO 10545-13	Minimum Class B Classe minima B			A	
Resistance to low concentrations of acids and alkalis Resistenza a basse concentrazioni di acidi e alcali		Declared Class Classe dichiarata			LA	
Resistance to high concentrations of acids and alkalis Resistenza ad alte concentrazioni di acidi e alcali		Declared Class Classe dichiarata			HA	
Resistance to staining Resistenza alle macchie	ISO 10545-14	Minimum Class 3 Classe 3 minima			5	
Release of dangerous substances: Cadmium (in mg/dm²) and Lead (in mg/dm²) Rilascio di sostanze pericolose: Cadmio (in mg/dm ²) e Piombo (in mg/dm ²)	ISO 10545-15	Declared value Valore dichiarato			≤ 0,01 mg/dm ² Cd ≤ 0,1 mg/dm ² Pb	

(*) The permissible deviation, in % or mm, of the average size for each tile (2 or 4 sides) from work size (WS). Deviazione ammissibile, in % oppure mm, della dimensione media di ogni piastrella (2 oppure 4 lati) dalla dimensione di fabbricazione (WS).
 (**) The permissible deviation, in % or mm, of the average thickness for each tile from the work size thickness (WS). Deviazione ammissibile, in % oppure mm, della spessore medio di ogni piastrella dallo spessore riportato nella dimensione di fabbricazione (WS).
 (***) The maximum permissible deviation from straightness, in % or mm, related to the corresponding work sizes (WS). Deviazione massima ammissibile di rettilineità, in % oppure mm, in rapporto alle dimensioni di fabbricazione (WS) corrispondenti.
 (****) The maximum permissible deviation from rectangularity, in % or mm, related to the corresponding work sizes (WS). Deviazione massima ammissibile di ortogonalità, in % oppure mm, in rapporto alle dimensioni di fabbricazione (WS) corrispondenti.
 c.c. The maximum permissible deviation from centre curvature, in % or mm, related to diagonal calculated from the work sizes (WS). Deviazione massima ammissibile della curvatura del centro, in % oppure mm, in rapporto alla diagonale calcolata secondo le dimensioni di fabbricazione (WS).
 e.c. The maximum permissible deviation from edge curvature, in % or mm, related to the corresponding work sizes (WS). Deviazione massima ammissibile della curvatura dello spigolo, in % oppure mm, in rapporto alle dimensioni di fabbricazione (WS) corrispondenti.
 w. The maximum permissible deviation from warpage, in % or mm, related to diagonal calculated from the work sizes (WS). Deviazione massima ammissibile dello sverglamento, in % oppure mm, in rapporto alla diagonale calcolata secondo le dimensioni di fabbricazione (WS).



BOOSTWORLD

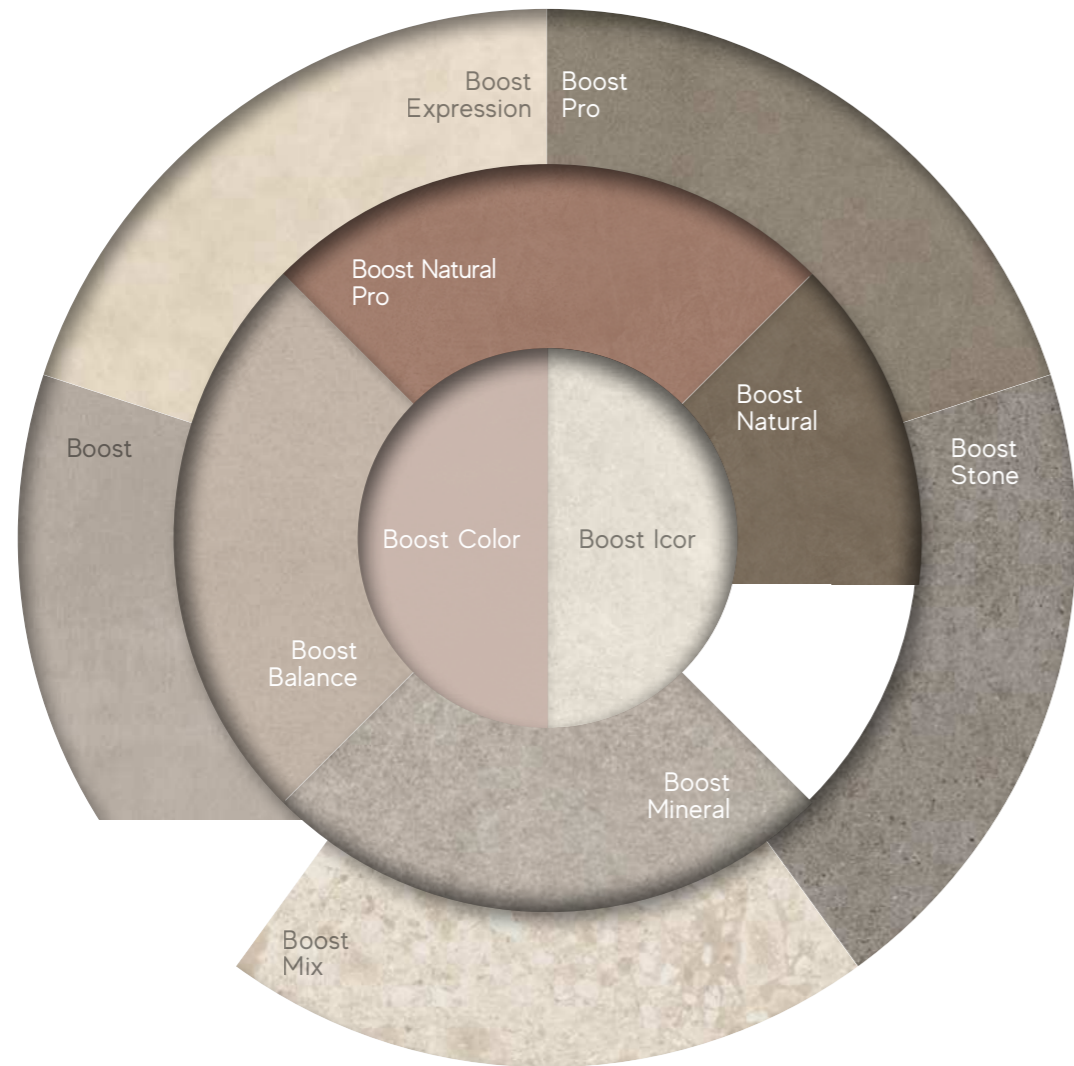

Boost your style

Boost World is a design tool that combines ceramic surfaces in their inspiration, style, and tone, allowing for coordinated solutions in any space.

Boost World è uno strumento progettuale che coniuga in un'unica prospettiva superfici ceramiche differenti per ispirazione ma affini per stile e tonalità, consentendo soluzioni coordinate in ogni destinazione d'uso.

DISCOVER
BOOST WORLD



Ethical identity



For Atlas Concorde, being Made in Italy is not just a prestigious certification of style, design, and production excellence, but an identity that involves all aspects of its business. For this reason, we identify with the values expressed by Confindustria Ceramica's ethical code, which guarantee absolute compliance with labor regulations, and with the marks Made in Italy and Ceramics of Italy, which certify the quality of authentic Italian style.

Per Atlas Concorde, Made in Italy non è solo un prestigioso attestato di stile, design ed eccellenza produttiva, ma un modo di essere che coinvolge tutti gli aspetti della propria attività. Per questo ci riconosciamo nei valori espressi dal codice etico di Confindustria Ceramica, che garantiscono il rispetto assoluto delle normative sul lavoro, e nei marchi Made in Italy e Ceramics of Italy, che certificano la qualità dell'autentico stile italiano.

Certifications

Company certifications / Certificazioni aziendali



Product declarations / Dichiarazioni di prodotto



Certifications for export to international markets*



Product certifications / Certificazioni di prodotto



Certification for buildings / Rating dell'edificio

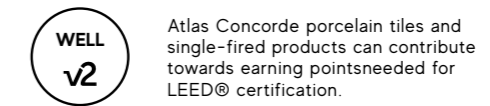

Ratings and Memberships



* Shipments can be made in accordance with national requirements anywhere in the world, even in markets with complex customs procedures such as Egypt, Morocco and Kurdistan, thanks to our active cooperation with accredited certification bodies in each country. - Possibilità di spedizioni conformi alle prescrizioni nazionali ovunque nel mondo, anche in mercati con procedure doganali complesse come Egitto, Marocco, Kurdistan, grazie alla collaborazione sempre attiva con gli enti di certificazione accreditati in ciascun paese. - Dank unserer aktiven Zusammenarbeit mit den akkreditierten Zertifizierungsstellen in den einzelnen Ländern können die Sendungen in Übereinstimmung mit den nationalen Anforderungen überall auf der Welt versandt werden, selbst auf Märkten mit komplexen Zollverfahren wie Ägypten, Marokko und Kurdistan. - Possibilité d'expéditions conformes aux prescriptions nationales partout dans le monde, même sur les marchés dont les procédures douanières sont complexes comme l'Égypte, le Maroc ou le Kurdistan, grâce à la collaboration toujours active avec les organismes de certification homologués dans chaque pays. - Se pueden realizar envíos según la normativa nacional a cualquier parte del mundo, incluso a mercados con procedimientos aduaneros complejos como Egipto, Marruecos o Kurdistan, gracias a la cooperación permanente con los organismos de certificación acreditados en cada país. - Компания имеет возможность осуществлять поставки в любую точку мира в соответствии с национальными требованиями, даже на рынках со сложными таможенными процедурами, таких как Египет, Марокко, Курдистан, благодаря неизменно активному сотрудничеству с аккредитованными органами сертификации в каждой стране.

¹⁰¹ Classificazione UPEC aggiornata al - Classement UPEC mis à jour au: 2024
¹⁰² Si consiglia la consultazione della pagina - On vous conseille de vous connecter à: <https://database.cstb.fr/holderdetails?UId=ETB-2094&AppRef=QB32>
¹⁰³ Per ulteriori informazioni scrivere a - Pour tous renseignements complémentaires merci d'écrire à: france@atlasconcorde.it
¹⁰⁴ Tutti i prodotti Atlas Concorde in gres porcellanato e in monocottura in pasta bianca possono essere utilizzati per progetti edili che seguono le linee guida del GREEN BUILDING COUNCIL e possono contribuire all'ottenimento del rating LEED V4 degli edifici.
 All Atlas Concorde porcelain tiles and white-body single-fired products can be used for building projects that follow the guidelines of the GREEN BUILDING COUNCIL and can contribute to the achievement of the LEED V4 rating for buildings.





atlasconcorde.com

Copyright 2024 by Ceramiche Atlas Concorde S.p.A
(41042 Spezzano di Fiorano (MO) - Italia)
September 2024